

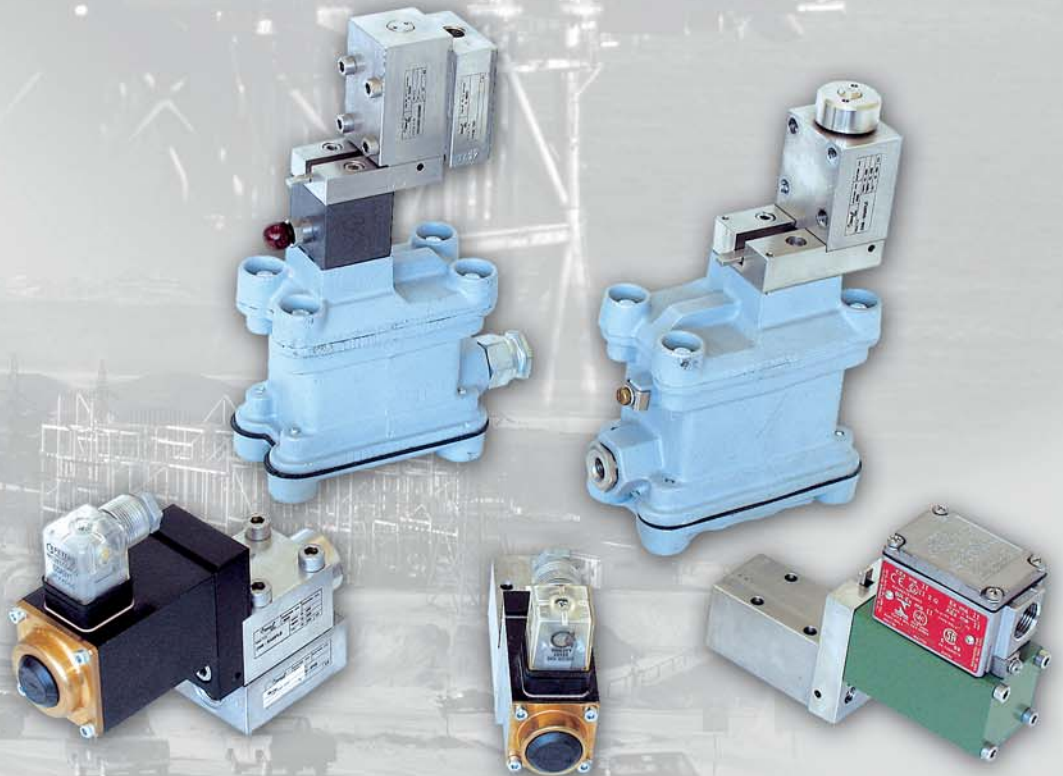

VERSA[®]

Valves

**High-Pressure Valves
Series H**



The H Series Leak-Proof, High-Pressure Valves

Versa Products Company has been supplying high quality pneumatic and hydraulic directional control valves and components for over 50 years. We have built a reputation for quality that is unsurpassed in a wide range of markets for high performance solenoids, pneumatic relays and resets and related components.

Versa's H Series is a range of leak-proof high-pressure valves suitable for low viscosity fluids that are ideally suited for the unique needs in the most demanding markets and applications. Low viscosity fluid may be mineral oils, high water based fluids, compressed air or natural gas. Standard valves are rated for hydraulic fluids up to 10.5 gpm (40 l/min) in 2-way and 3-way functions.

Apply Versa's optional pneumatic service suffix and many forms of gas can be controlled in various flow configurations. Valves are available with solenoid or pilot actuation and manual overrides are standard. H Series valves are constructed of stainless steel materials, as standard. All valves are manifold mounted style with a number of standard manifold configurations. Custom manifolding, circuitry and non-standard functions can be easily developed upon request.

Major market applications are within the Oil and Gas industry, however H Series valves have been successfully applied in mining, steel, utility, fire-fighting, desalination and more.

Corrosion resistant materials.

Standard materials are 316 stainless steel for compatibility with the widest range of medias in almost any service.

Dynamically balanced sealing assembly.

Regardless of application pressures, internal components are balanced via the operating fluid to assure positive shifting. No false shifts due to pressure spikes.

Pullout design.

Internals pullout for easy removal of key parts simplifying service and maintenance

'O' Ring static sealing.

Positive sealing via standard 'O' rings. No custom or flat gaskets to leak. Standard 'O' rings available in every tool bin.

Ceramic sealing for leak free sealing. Hardened sealing surfaces for long service life. Materials compatible with the widest range of medias and services.

Standard override on every valve.

Easy setup of equipment. Field-testing and equipment trouble shooting are greatly simplified.

Actuator shifting lever.

The ASL assures positive shifting through mechanical advantage. The ASL also reduces the force or power requirements to allow for a number of actuators. Many different solenoids are offered with low wattage requirements. A pilot actuator may also be selected, shifting the valve with a low-pressure signal.

Modular design

for standardized components. This modular design allows for field conversions and the availability of replacement assemblies.

Manifold mounted. All valves are manifold mounted for easy removal. No need to disturb system piping. All piping accomplished in the manifold base.

H Series Specifications

Function

The H Series is a line of stainless or aluminum manifold mounted valves available as 2-way or 3-way, normally open or closed function. Valve function is not field convertible therefore specify function as required. For other functions consult factory.

Service Media

Hydraulic Service. The standard H Series valve is rated for hydraulic media. Typical hydraulic fluids are considered mineral oil, synthetic oils, water and water glycol. All applications to be confirmed by factory. High-pressure hydraulic service is also available, see pressure chart.

Pneumatic Service. H Series valves are rated for pneumatic service, suffix detail option required. See pressure chart. Pneumatic service would be high-pressure air, inert gasses, natural gas and sour gas. All valves, with pneumatic service option are rated for non-lube service, however lubrication is recommended when feasible.

Flow/Pressure Ratings

Flow		Pressure Rating				
		Hydraulic		Pneumatic		
Valve Size	Cv	GPM (l/min)	Standard Valve no suffix PSI (bar)	Suffix -HP2 PSI (bar)	Suffix -AS PSI (bar)	Suffix -AS1 PSI (bar)
H02	0.06	0.3 (0.9)	10,000 (690)	N/A	N/A	N/A
H03	0.23	1.2 (5)	6,000 (414)	10,000 (690)	2,320 (160)	3,625 (250)
H06	0.79	4.0 (15)	6,000 (414)	N/A	2,320 (160)	3,625 (250)
H10	1.9	10.5 (40)	5,000 (345)	N/A	1,450 (100)	N/A

Pressures listed above are maximum body pressures. Minimum pressures are based on actuator selection, see actuator section for minimum pressure ratings.

All valves are tested prior to shipment.

Test pressures are 1.5 times rated pressures for hydraulic service.

Pneumatic valves are tested at rated pressures.

For higher flows and or pressures contact factory.

General Specifications

Temperature range

Temperature range is based on actuator selection. Please see page 4 for temperature information.

Filtration

Hydraulic Service: 10 micron (H02 size)
20 micron (H03, H06 and H10 size)
Pneumatic Service: 20 micron (all sizes)

Materials of Construction

Main Body:	316 Stainless steel (standard) 430F Stainless steel (optional, add suffix -430) Aluminum, anodized (optional, add suffix -AL)
Seals, dynamic:	Ceramic seal with stainless steel seat (hydraulic service, standard and suffix - HP2) Ceramic seal with engineered polymer seat (pneumatic service, suffix -AS and -AS1)
Seals, Static:	Buna
Fasteners:	Stainless steel
Manifold:	See manifold section

Versa exercises diligence to assure that information contained in this catalog is correct, but does not accept responsibility for any errors or omissions. Versa also reserves the right to change or delete data or products at any time without prior notification. To be sure the data you require is correct, consult factory.

Actuators



XB



XF



XD

Solenoids



XC



XE

Suffix Detail: XB

Hazardous Location – Flameproof – ATEX*
Protection Classification: II 2G EE_x de IIB + H₂ T4/T6
Area Classification: ZONE 1
Ingress Protection: IP54
Voltage: 12 to 250 Volts AC or DC
Power: H3 13 to 17 Watts, H6 20 Watts
Electrical Connection: M20x1.5 w/PG16 cord grip
Temperature Rating: T4: -4F to 158F (-20C to 70C)
 T6: -4F to 104F (-20C to 40C)

Suffix Detail: XC

Hazardous Location – Flameproof – ATEX*
Protection Classification: II 2G EE_x d IIC T6
Area Classification: ZONE 1
Ingress Protection: IP65
Voltage: Up to 250 Volts DC
Power: 3 Watts
Electrical Connection: M20x1.5
Temperature Rating: T6 – 4F to 140F (-20C to 60C)

Suffix Detail: XD

Hazardous Location – Intrinsic Safe – ATEX
Protection Classification: II 2G EE_x ia IIC T5/T6
Area Classification: ZONE 1
Ingress Protection: IP54
Voltage: 5 to 24 Volts DC
Power: up to 2 Watts
Electrical Connection: PG7 cord grip
Temperature Rating: T6 – 4F to 140F (-20C to 60C)
 T5 – 4F to 158F (-20C to 70C)

Suffix Detail: XE

Hazardous Location – Encapsulation – ATEX
Protection Classification: II 2G EE_x me II T5/T6
Area Classification: ZONE 1
Ingress Protection: IP65 (Use – XEX for IP66/68)
Voltage: 12 to 125 Volts DC
Power: 3 Watts
Electrical Connection: M20x1.5
Temperature Rating: T6 – 4F to 122F (-20C to 50C)
 T5 – 4F to 140F (-20C to 60C)

Suffix Detail: XF

General Purpose
Area Classification: None
Ingress Protection: IP54
Voltage: 12 to 250 Volts AC or DC
Power: H2/H3 13 Watts, H6 36 Watts
Electrical Connection: PG9 cord grip
Temperature Rating: -4F to 176F (-20C to 80C)

*Consult factory for North American Ratings

Pilots

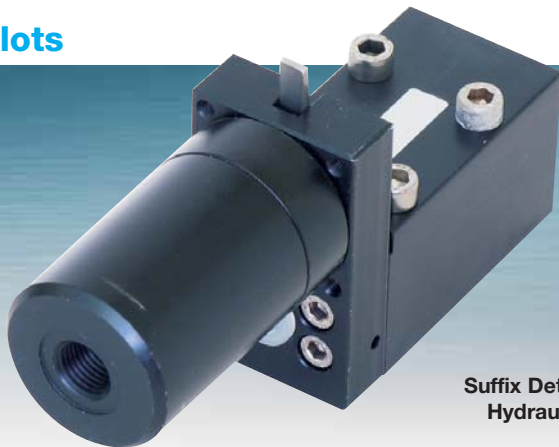

Suffix Detail: HP
Hydraulic Pilot

Suffix Detail: AP
Pneumatic Pilot

Latches



Suffix Detail: LP-1
Latching Manual Reset

Operation: Latches in the de-energized position. With loss of solenoid (or pilot) signal, the valve shifts closed and cannot be re-shifted until manually reset.

H Series Quick Reference Part Number Selector

(Part numbers listed below are for standard hydraulic service. For other applications, suffix options are required. Part numbers include valve and actuators only. A manifold is required to complete the assembly part number. See page 6 for manifolds.)

Solenoid actuated

2-Way and 3-Way normally closed 2-position single solenoid, spring return valves

Valve	Function	EEx de Solenoid	EEx d Solenoid	EEx ia Solenoid	EEx me Solenoid	General Purpose Solenoid
H02	2-Way NC	N/A	HSG-20201-XC-* See note 1	HSG-20201-XD-* See note 1	HSG-20201-XE-* See note 1	HSG-20201-XF-* See note 1
	3-Way NC	N/A	HSG-30201-XC-* See note 1	HSG-30201-XD-* See note 1	HSG-30201-XE-* See note 1	HSG-30201-XF-* See note 1
H03	2-Way NC	HSG-20301-XB-* See note 1	HSG-20321-XC-* See note 2	HSG-20321-XD-* See note 2	HSG-20321-XE-* See note 2	HSG-20301-XF-* See note 1
	3-Way NC	HSG-30301-XB-* See note 1	HSG-30321-XC-* See note 2	HSG-30321-XD-* See note 2	HSG-30321-XE-* See note 2	HSG-30301-XF-* See note 1
H06	2-Way NC	HSG-20601-XB-* See note 1	HSG-20621-XC-* See note 2	HSG-20621-XD-* See note 2	HSG-20621-XE-* See note 2	HSG-20601-XF-* See note 1
	3-Way NC	HSG-30601-XB-* See note 1	HSG-30621-XC-* See note 2	HSG-30621-XD-* See note 2	HSG-30621-XE-* See note 2	HSG-30601-XF-* See note 1
H10	2-Way NC	HSG-21031-XB-* See note 2	HSG-21021-XC-* See note 2	HSG-21021-XD-* See note 2	HSG-21021-XE-* See note 2	HSG-21021-XF-* See note 2
	3-Way NC	HSG-31031-XB-* See note 2	HSG-31021-XC-* See note 2	HSG-31021-XD-* See note 2	HSG-31021-XE-* See note 2	HSG-31021-XF-* See note 2

*Must add voltage code. See voltage code on page 6.

Pressure Ratings:

Maximum main body pressure is listed on flow/pressure chart. For higher-pressure hydraulic or pneumatic service select suffix option as required on flow/pressure chart. **Minimum pressures are as follows:**

1. Minimum inlet pressure is 0 psi. Valve is a direct acting design.
2. Minimum inlet pressure is 435 psi (30 bar). Valve is a solenoid-pilot design.

All solenoid-operated valves are supplied with manual over-ride. XL solenoid valves are supplied with push button type override. All other valves utilize lever type over-ride. Part numbers reflect normally closed valves. For normally open function change last digit on base number from 1 to 2.

Pilot actuated

2-Way and 3-Way normally closed 2-position single pilot, spring return valves

Valve Size	Function	Hydraulic Pilot	Pneumatic Pilot
H03	2-Way, NC	HSP-20301-HP	HSP-20301-AP
	3-Way, NC	HSP-30301-HP	HSP-30301-AP
H06	2-Way, NC	HSP-20601-HP	HSP-20601-AP
	3-Way, NC	HSP-30601-HP	HSP-30601-AP
H10		Consult Factory	

Pressure Rating:

Maximum main body pressure is listed on flow/pressure chart. For higher-pressure hydraulic or pneumatic service select suffix option as required on flow/pressure chart. **Minimum main body pressure for all pilot valves is 0 psi.**

- Pilot shift pressure, all sizes: 50 psi (3.4 bar) Hydraulic/45 psi (3 bar) Pneumatic Pilot
- Pilot maximum pressure, all sizes: 3050 psi (210 bar) Hydraulic/232 psi (16 bar) Pneumatic Pilot

All pilot operated valves are supplied with manual override. Part numbers reflect normally closed valves. For normally open function change last digit on base number from 1 to 2.

SG = Actuator

SG = Solenoid operated, spring return
 SP = Pilot operated, spring return

XB = Actuator Suffix Options

AP = Pilot Operated valve, Pneumatic signal
 HP = Pilot Operated valve, Hydraulic signal
 XB = Solenoid enclosure, Protection level EEx de
 XC = Solenoid enclosure, Protection level EEx d
 XD = Solenoid enclosure, Protection level EEx ia
 XE = Solenoid enclosure, Protection level EEx me
 XEX = Solenoid enclosure, Protection level EEx me, IP66/68
 XF = Solenoid enclosure, General purpose, DIN Connector

H Series Product Line

3 = Function
 2 = 2-Way
 3 = 3-Way

03 = Main Valve Size
 02 = H02 Size
 03 = H03 Size
 06 = H06 Size
 10 = H10 Size

H S G - 3 0 3 0 1 - X B - 4 3 0 - D 0 2 4

VALVE, SAMPLE CODE

1 = Spool Function
 1 = Normally Closed
 2 = Normally Opened

D024 = Voltage
 D024 = 24 Volts, DC
 A120 = 120 Volts, 60 Hz.
 E110 = 110 Volts, 50 Hz.
 (consult factory for other voltages)

0 = Solenoid-Pilot Operator
 (as determined by actuator)
 0 = For Solenoid and pilot valves – No solenoid-pilot operator required.
 2 = For Solenoid valves
 H02 Solenoid-pilot operator required.
 3 = For Solenoid valves
 H03 Solenoid-pilot operator required.
 6 = For Solenoid valves
 H06 Solenoid-pilot operator required.

430 = Valve Suffix Options
 None = 316 stainless steel, std.
 AL = Aluminum body materials
 430 = Stainless Steel Materials
 HP2 = Hydraulic service valve, High pressure ratings
 AS = Pneumatic service valve, Standard pressure ratings
 AS1 = Pneumatic service valve, High pressure ratings
 LP1 = Latching valve
 (consult factory for availability)

H Series ordering codes

How to specify a Versa Series H part number

The bold face captions (shown in color) explain the meaning of the two large sample codes. Alternative codes are shown beneath the captions in black type. Not all options available in all sizes. Please confirm part number with Versa Products Co.

03 = Main Valve Size

02 = H02 Size
 03 = H03 Size
 06 = H06 Size
 10 = H10 Size

3 = Function
 2 = 2-Way
 3 = 3-Way

1 = Connection Type

Consult factory for Autoclave and SAE
 1 = NPT
 2 = 'G'

H Series Product Line

M = H Series Single Station Manifold

Consult factory for custom or multi station manifolds

03 = Size

02 = 1/8
 03 = 1/4
 04 = 3/8
 05 = 1/2
 06 = 3/4
 07 = 1

Material

316 = Stainless steel
 430 = Stainless steel
 AL = Aluminum

H 3 M - 3 0 3 1 - 3 1 6

H Series dimensions

Solenoid Actuated – General Purpose Area Classification

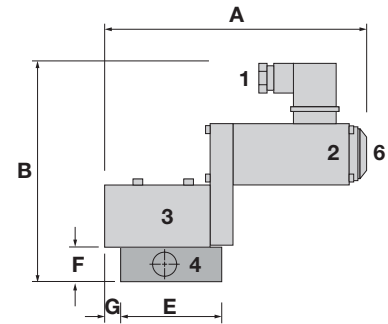
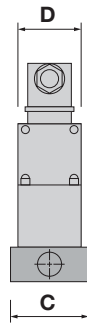

Valve Base Number	A		B		C		D		E		F		G	
	in	mm	in	mm	in	mm	in	mm	in	mm	in	mm	in	mm
HSG-30201-XF	5.04	128	6.38	162	1.97	50	1.57	40	2.36	60	1.18	30	0.12	3
HSG-30301-XF	6.08	154.5	5.67	144	1.97	50	1.57	40	2.56	65	1.18	30	0.31	8
HSG-30601-XF	7.36	187	6.18	157	1.97	50	1.97	50	2.76	70	1.18	30	0.47	12

Note:

Dimensions are for reference purposes only. Consult factory for layout drawings and actual dimensioning for exact valve selected as product dimensions change with options selected.

Valves are shown on single station 3-way sub-plates. 2-way function does not change overall sizes. Manual overrides for the -XF solenoid option are push button style. All other solenoid options utilize a lever style override (similar to override on pilot actuated valves).

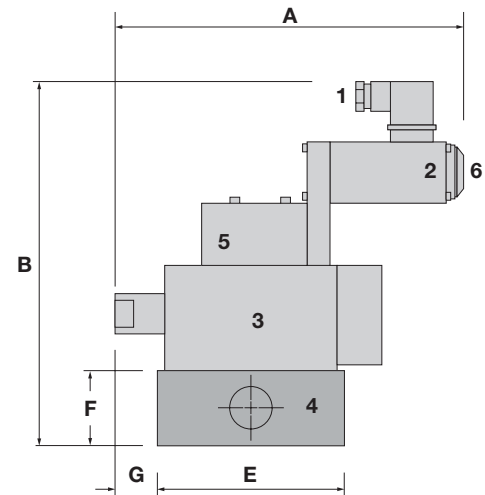
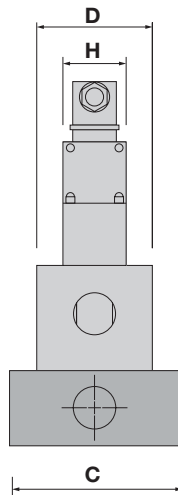

Valve Base Number	A		B		C		D		E		F		G		H	
	in	mm	in	mm	in	mm	in	mm	in	mm	in	mm	in	mm	in	mm
HSG-31021-XF	7.89	200.5	9.84	250	4.33	110	2.76	70	4.72	120	1.97	50	1.56	39.5	1.57	40

Legend:

- Conduit Entry 1
- Solenoid Enclosure 2
- Main Valve Body 3
- Manifold 4
- Solenoid-Pilot Valve 5
- Manual Over-ride 6
- Pilot Actuator 7
- Pilot Port 8

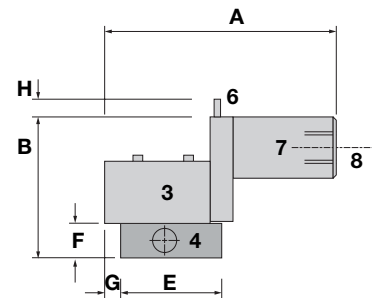
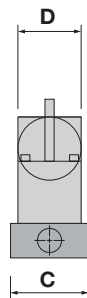

Valve Base Number	A		B		C		D		E		F		G		H	
	in	mm	in	mm	in	mm	in	mm	in	mm	in	mm	in	mm	in	mm
HSP-30301-AP	5.91	150	3.94	100	1.97	50	1.57	40	2.56	65	1.18	30	0.31	8	0.41	10.5
HSP-30601-AP	6.30	160	4.21	107	1.97	50	1.97	50	2.76	70	1.18	30	0.47	12	0.41	10.5



Versa has been supplying the oil and gas industry with pneumatic and hydraulic components for over 50 years. We have built a reputation for quality that is unsurpassed in the market for high performance solenoids, pneumatic relays and resets, and pilot valves.



WARNINGS REGARDING THE DESIGN APPLICATION, INSTALLATION AND SERVICE OF VERSA PRODUCTS

The warnings below must be read and reviewed before designing a system utilizing, installing, servicing, or removing a Versa product. Improper use, installation or servicing of a Versa product could create a hazard to personnel and property.

DESIGN APPLICATION WARNINGS

Versa products are intended for use where compressed air or industrial hydraulic fluids are present. For use with media other than specified or for non-industrial applications or other applications not within published specifications, consult Versa.

Versa products are not inherently dangerous. They are only a component of a larger system. The system in which a Versa product is used must include adequate safeguards to prevent injury or damage in the event of system or product failure, whether this failure be of switches, regulators, cylinders, valves or any other system component. System designers must provide adequate warnings for each system in which a Versa product is utilized. These warnings, including those set forth herein, should be provided by the designer to those who will come in contact with the system.

Where questions exist regarding the applicability of a Versa product to a given use, inquiries should be addressed directly to the manufacturer. Confirmation should be obtained directly from the manufacturer regarding any questioned application prior to proceeding.

INSTALLATION, OPERATION AND SERVICE WARNINGS

Do not install or service any Versa product on a system or machine without first depressurizing the system and turning off any air, fluid, or electricity to the system or machine. All applicable electrical, mechanical, and safety codes, as well as applicable governmental regulations and laws must be complied with when installing or servicing a Versa product.

Versa products should only be installed or serviced by qualified, knowledgeable personnel who understand how these specific products are to be installed and operated. The individual must be familiar with the particular specifications, including specifications for temperature, pressure, lubrication, environment and filtration for the Versa product which is being installed or serviced. Specifications may be obtained upon request directly from Versa. If damages should occur to a Versa product, do not Operate the system containing the Versa product. Consult Versa for technical information.

LIMITED WARRANTY DISCLAIMER AND LIMITATION OF REMEDIES

Versa's H Series products are warranted to be free from defective material and workmanship for a period of three years from the date of manufacture, provided said H Series products are used in accordance with Versa specifications. Versa's liability pursuant to that warranty is limited to the replacement of the Versa product proved to be defective provided the allegedly defective product is returned to Versa or its authorized distributor. Versa provides no other warranties, expressed or implied, except as stated above. There are no implied warranties of merchantability or fitness for a particular purpose. Versa's liability for breach of warranty as herein stated is the only and exclusive remedy and in no event shall Versa be responsible or liable for incidental or consequential damages.

Versa Products Company Inc.

22 Spring Valley Road
Paramus, New Jersey 07652
USA
Phone: 201-843-2400
Fax: 201-843-2931

Versa BV

Prins Willem Alexanderlaan 1429
7321 GB Apeldoorn
The Netherlands
Phone: 01131-55-368-1900
Fax: 01131-55-368-1909



www.versa-valves.com
email: sales@versa-valves.com